



DE Montageanleitung Außentreppe Scarvo

EN Instructions external staircase Scarvo

FR Instructions d'installation escalier extérieur Scarvo

ES Instrucciones de montaje de la escalera exterior Scarvo



Inhaltverzeichnis

1. Notwendige Vorarbeiten	3
2. Stückliste	4-6
3. Berechnung des Stufenabstandes	7
4. Montage weitere Etagen	8-9
5. Montage	10-21



Table of Contents

1. Required preliminary work	22
2. Scarvo Outside Staircase parts list	23-25
3. Calculation of step spacing	26
4. Assembly of additional floors	27-28
5. Assembly	29-40



Sommaire

1. Préparatifs nécessaires	41
2. Liste des pièces pour l'escalier extérieur Scarvo	42-44
3. Calcul des hauteurs de marche	45
4. Assemblage d'étages supplémentaires	46-47
5. Montage	48-59



Índice

1. Trabajos previos necesarios	60
2. Lista de piezas - escalera exterior Scarvo	61-63
3. Cálculo de la distancia entre escalones	64
4. Montaje de más plantas	65-66
5. Montaje	67-78



Montageanleitung Außentreppe Scarvo

1) Notwendige Vorarbeiten

Die Fundament-Angaben entsprechen normalen Bodenverhältnissen bei gewachsenem Erdreich.

Betonmaterial: Bn25

Frostfrei gegründet (ca.80 cm) auf gewachsenem Boden!

Abmaße Fundament:

	Ø 130	Ø 160	Ø 180	Ø 225
L	55x55x80 cm	55x55x80 cm	55x55x80 cm	55x55x80 cm
XL	55x55x80 cm	55x55x80 cm	60x60x80 cm	65x65x80 cm
XXL	55x55x80 cm	55x55x80 cm	65x65x80 cm	70x70x80 cm



















Hilfsmittel zur Montage der Außentreppe:

- (Schlag-)Bohrmaschine, Akku-Schrauber
- Schraubendreher (Torx)
- Innensechskantschlüssel (z.B. Inbus) 3 mm, 4 mm, 5 mm
- Bandmaß, Taschenrechner
- Hammer, Kombizange
- Schraubenschlüssel SW10 mm
- Wasserwaage
- Metallsäge
- Leiter



Montageanleitung Außentreppe Scarvo

2) Stückliste Außentreppe Scarvo

#	Bezeichnung	Techn. Info	Abbildung	
			Standard	Premium
1.	Fußplatte mit Rohrmuffe			
2.	Ronde			
3.	Geländerstab gekröpft			
4.1.	Schraube A2 Halbrundkopf	6x25 mm		
4.2.	Senkkopfschraube	M6x16 mm		
5.	Gewindestift	M8x8 mm		
6.	Handlaufverbinder			
7.	Sockel für Podeststab			
8.	Zentralstandrohr			
9.	Spannhülse A2			
10.	Handlaufhalter			
11.	Schraube A2 Linsenkopf	4,8x13 mm		
12.	Gewindestift	M6x5 mm		
13.	Handlauf-Podest			



Montageanleitung Außentreppe Scarvo





2) Stückliste Außentreppe Scarvo

#	Bezeichnung	Techn. Info	Abbildung	
			Standard	Premium
14.	Universalanschluss			
15.	Geländerstab gerade			
16.	Abschlussrohr oben			
17.	Podeste mit Streckgitter			
18.	Stufen mit Streckgitter			
19.	Schraube A2 Senkkopf	4,8x16 mm		
20.	Rohrstopfen Geländerstab	Ø20 mm		
21.	Handlauf-Rohrbogensegment	Ø40 mm		
22.	Handlaufrohr Endstopfen	Ø40 mm		
23.	Bit	TORX 25		
24.	Zink-Alu Spray	400 ml		
25.	Gewindebohrer	M6 mm		
26.	Kabelbinder	2,6x100 mm		
27.	Spiralbohrer	Ø 4 mm Ø 5 mm		



Montageanleitung Außentreppe Scarvo

2) Stückliste Außentreppe Scarvo

#	Bezeichnung	Techn. Info	Abbildung	
			Standard	Premium
28.	Sechskantschraube A2	Stahl: M6x35 mm WPC: M6x60 mm		
29.	Sechskantschraube A2	M6x50 mm		
30.	Gewindestift	10x8 mm		
31.	Standrohradapter			
32.	Standrohrverstärker			



Montageanleitung Außentreppe Scarvo

3) Berechnung des Stufenabstands

Durch die unterschiedlichen Geschosshöhen muss die Stufenhöhe individuell berechnet werden. Messe die Geschosshöhe **H** von dem Fußboden bis zur Oberkante des Fußbodens der Deckenöffnung. Dividiere (:) die Geschosshöhe **H** durch die Anzahl der Stufen + Podest.

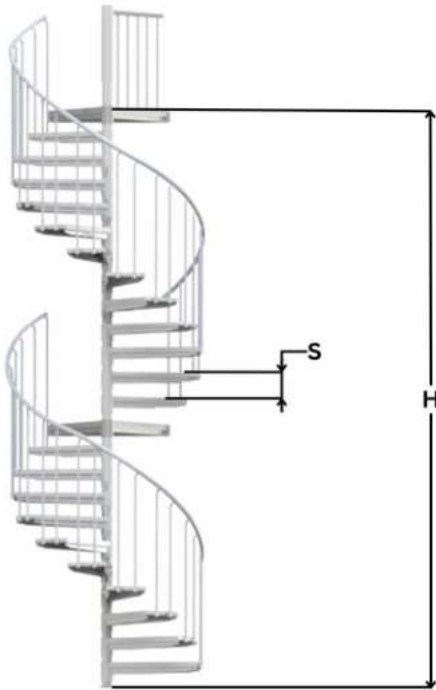

Beispiel:

$$S = \frac{H}{\text{Stufenanzahl} + \text{Podestanzahl}}$$
$$S = \frac{252 \text{ cm}}{11 \text{ Stufen} + 1 \text{ Podest}}$$
$$S = 21 \text{ cm}$$



Das Befestigungsmaterial für die Montage des Podestes an dem Gebäude und für die Montage der Fußplatte am Boden liegt nicht bei.

Bitte prüfe in regelmäßigen Abständen alle sich an der Wendeltreppe befindlichen Schraubverbindungen.

Für Schäden, die durch unsachgemäße Montage entstehen, wird keine Haftung übernommen.



Montageanleitung Außentreppe Scarvo

4) Montage weitere Etagen

Verbinden der Standrohre

Die Spindeltreppen Scarvo L bis XXL beinhalten 2-4 Standrohre. Die Standrohre werden je nach Variation mit einem Standrohradapter (31) oder einem Standrohrverstärker (32) miteinander verbunden. Der Standrohradapter wird in das Standrohr gesteckt und mit den mitgelieferten Gewindestiften (30) fixiert. Die Standrohrverlängerung wird bis zum Anschlag im Standrohr versenkt, sodass der Verstärker noch etwa 150 mm aus dem Standrohr herausragt. Auch der Standrohrverstärker wird mit den Gewindestiften (30) fixiert.

Sind sowohl Standrohrverstärker, sowie Standrohradapter im Lieferumfang enthalten verwende zuerst die Standrohrverstärker und im oberen Bereich der Treppe die Standrohradapter.

Ablauf der Montageschritte

Der erste Teil der Treppe wird nach Montageanleitung durchgeführt, hierbei werden die Schritte 13 und 15 übersprungen. Jetzt muss ein weiteres Standrohr montiert werden.

Der zweite Teil der Treppe wird ohne die Schritte 1-3 der Montageanleitung wie beschrieben aufgebaut. (Bei einer Scarvo L ist die Montage hier abgeschlossen)

Handelt es sich bei der Treppe um eine Scarvo XL oder XXL entfallen auch im zweiten Teil der Treppe die Schritte 13 und 15. Nun wird das dritte Standrohr angebracht.

Der Aufbau des dritten Treppenteils erfolgt erneut ohne die Schritte 1-3 der Anleitung. Handelt es sich um eine Scarvo XL führe alle weiteren Schritte der Montageanleitung durch. Bei einer Scarvo XXL müssen erneut die Schritte 13 und 15 übersprungen werden. Jetzt wird das letzte Standrohr benötigt. Ist das Standrohr befestigt, wird die Montage ab Schritt 4 durchgeführt.

Bemerkung:

Die mitgelieferten Gewindestifte Pos. (30) für die Verbindung der Standrohre durch Standrohradapter / Standrohrverstärker sollten fest angezogen werden, Richtwert 10-12Nm.



Montageanleitung Außentreppe Scarvo

4) Montage weitere Etagen

Wichtig dabei zu beachten ist:

- Um eine 360 Grad-Wendelung hinzubekommen, muss die obere Treppe (von Zwischenpodest bis oberem Podest) mit mindestens einer Zusatzstufe montiert werden (12 Stufen, Überlappung = 0 cm).
- Die Stufenhöhe sollte nicht 17,5cm unterschreiten (Problem mit dem Geländer Ø).
- Das Podest muss nicht zwangsläufig genau höhenmittig positioniert werden.
- Bei einer Überlappung von max. 2,3 cm dürfen sich in dem oberen Bereich der Treppe (von Zwischenpodest bis oberstem Podest) maximal 13 Stufen und ein Podest (14 Steigungen) befinden. Bei 23 (!) cm Steigungshöhe kommt man so mit der oberen Treppe auf maximal 322 cm. Soll eine größere Höhe erreicht werden, müssen mehr Stufen eingesetzt werden, dadurch vergrößert sich die Überlappung der Stufen.



Montageanleitung Außentreppe Scarvo

5) Montage

Schritt 1

Beginne damit das Fundament zu gießen. Die Maße des Fundaments kannst du der oben stehenden Tabelle (Seite 3) passend zu deiner Treppe entnehmen.

Um das Fundament im richtigen Abstand zur Wand zu gießen, entnehme die Maße passend zu deinem Durchmesser aus der Tabelle.

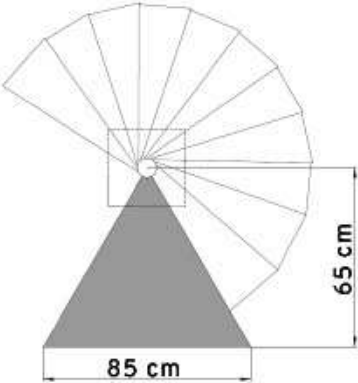
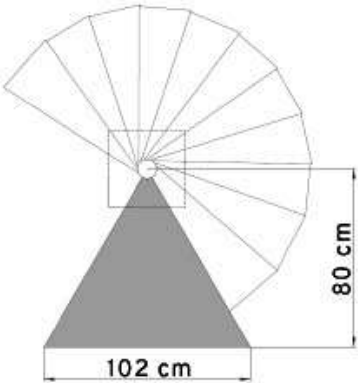
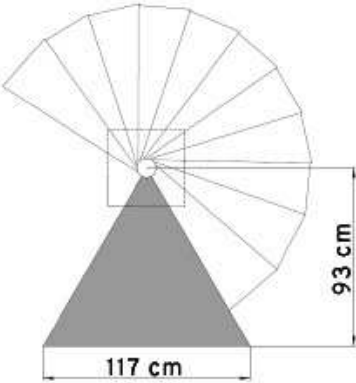
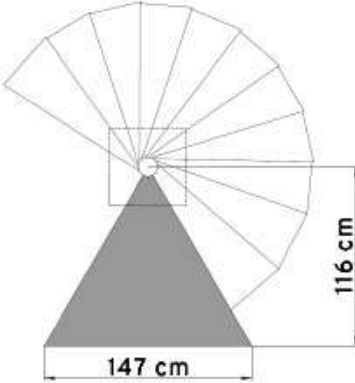
Ø 130 cm	Ø 160 cm
	
Ø 180 cm	Ø 225 cm
	



Montageanleitung Außentreppe Scarvo

5) Montage

Schritt 2

Zuerst wird die Fußplatte montiert. Um die Löcher an den richtigen Stellen zu bohren, sollte man die Fußplatte (1) auf das Fundament auflegen und die dort vorgegebenen Löcher mit einem Bleistift nachzeichnen (Bild 1). Bei der Ausrichtung der Fußplatte ist der passende Abstand zur Wand zu beachten. Die passenden Abstände entnehme der Tabelle. (Seite 10)



Schritt 3

Im zweiten Schritt muss die Fußplatte (1) auf dem Fundament befestigt werden (Bild 1). Im Anschluss stecke das Zentral-Standrohr (8) auf die am Boden befestigte Fußplatte und fixiere dies mit den mitgelieferten Gewindestiften (30) (Bild 2).

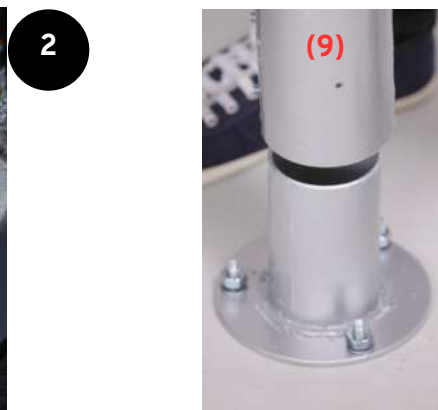



Montageanleitung Außentreppe Scarvo

5) Montage

Schritt 4

Wenn das Zentral-Standrohr steht, kann mit dem Auffädeln der Stufen (18) begonnen werden. Dafür schiebe die Stufen einfach auf das Standrohr übereinander (Bild 1). Um eine bessere Stabilität zu gewährleisten, benutze ein Hilfsmittel wie z.B. ein Kantholz und lege die erste Stufe auf das Kantholz (Bild 2).

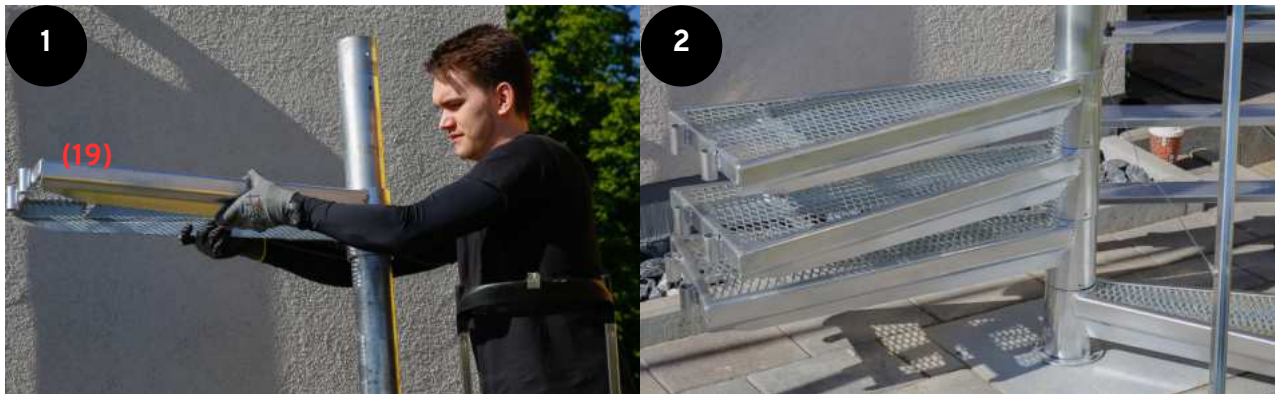

Schritt 5

Sind alle Stufen aufgefädelt, kann das Podest (17) auf das Zentral-Standrohr montiert werden. Dazu richte das Podest bündig mit der Oberkante des Fertigfußbodens aus und verschraube es mit der Wand (Bild 1). Anschließend richte das Podest mit einer Wasserwaage aus und befestige dieses an dem Zentral-Standrohr. Verwende dafür die mitgelieferten Gewindestifte (5) (Bild 2). Bitte beachte, dass du bei einer Holzdecke mindestens 10x60 mm Schlüsselschrauben und bei einer Betondecke Schwerlastdübel verwenden musst.





Montageanleitung Außentreppe Scarvo

5) Montage

Schritt 6

Im Anschluss müssen die einzelnen Stufenabstände markiert und die Stufen ausgerichtet werden. Orientierungslinien erleichtern das spätere Ausrichten der Stufen. Der Stufenabstand lässt sich ganz einfach ermitteln: Geschosshöhe H / (11 Stufen + 1 Podest). Die Fixierung eines Maßbandes am Standrohr vereinfacht die Arbeit ungemein (Bild 1). Fange mit der ersten Stufe von oben an. Lasse die Stufen am Stufenende 1 cm überlappen. Befestige die Stufen mit den Gewindestiften (5) (Bild 2). Diesen Schritt führe bei allen Stufen durch.



Schritt 7

Nun werden zuerst die hinteren Geländerstäbe (3) in die Geländerhalter am Ende der Stufe eingesetzt (Bild 1). Befestige die Stäbe zunächst mit den Gewindestiften (12) (Bild 2). Die Kröpfung der Stäbe zeigt entgegen der Laufrichtung (von unten nach oben gesehen).

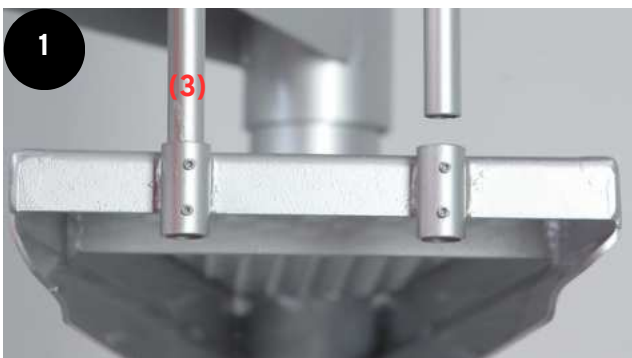



Montageanleitung Außentreppe Scarvo

5) Montage

Schritt 8

Setze nun die vorderen Geländerstäbe ein und lasse diese ca. 13 cm nach unten herausstehen.

Schritt 9

Verschraube die Teile des Handlaufhalters (10) mit der Schraube (4). Im Anschluss stecke den Handlaufhalter auf die Geländerstäbe.



Schritt 10

Setze nun die Handlauf-Rohrbogensegmente (21) auf die Handlaufhalter und befestige diese provisorisch mit den mitgelieferten Kabelbindern (26) (Bild 1). Beginne von unten. Stecke die Handlaufsegmente mittels Handlaufverbinder (6) zusammen (Bild 2).

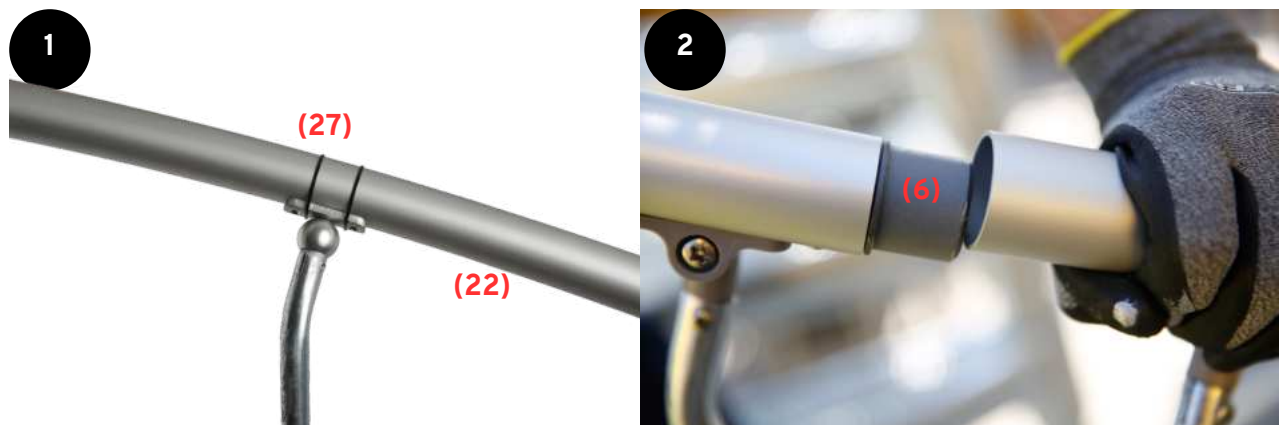



Montageanleitung Außentreppe Scarvo

5) Montage

Nun richte die Laschen parallel zum Handlauf aus, indem du die Kugel in den Stab drehst. Durch das Verdrehen der Stange kann der Winkel der Lasche verändert werden (Bild 3).

Wichtig: Die Senkrechthaltung der Stäbe durch Anwendung einer Wasserwaage überprüfen (Bild 4).

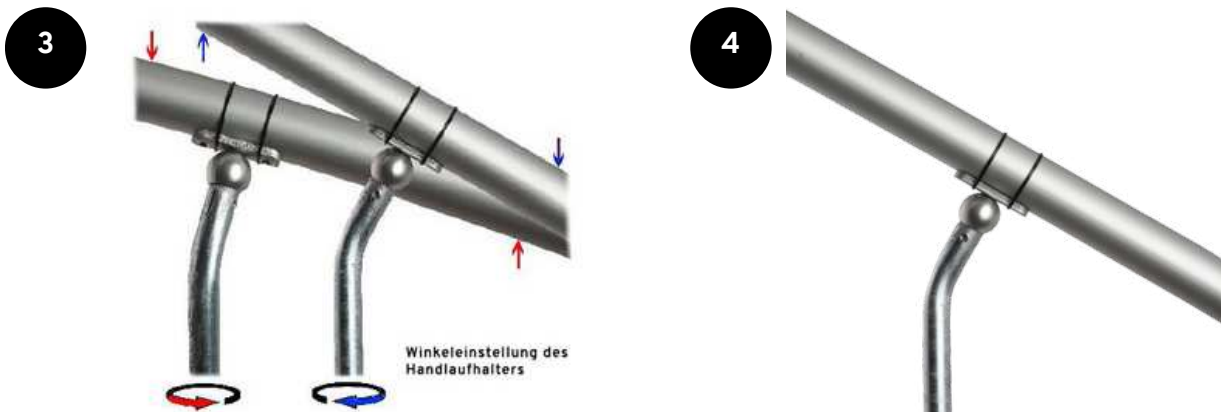

Wenn diese ausgerichtet sind, verschraube den Halter mit dem Geländerstab mit der Flachkopfschraube (11).

Im nächsten Schritt zeichne mit einem Bleistift die Löcher vor und bohre diese mit dem mitgelieferten Bohrer Ø4 mm (27) in den Handlauf. Anschließend nimm die Senkkopfschrauben (19) und verschraube den Handlaufhalter mit dem Handlaufrohr (Bild 5).

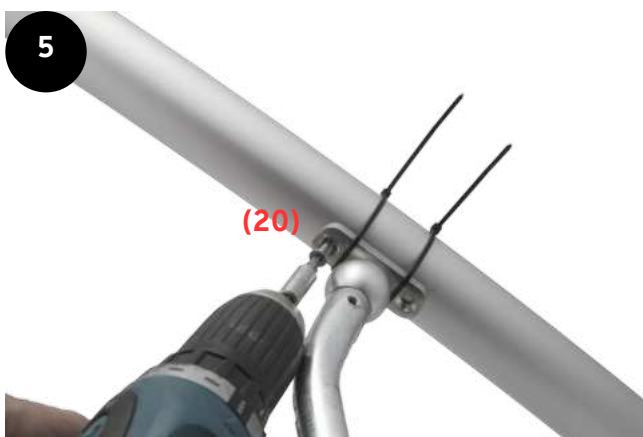



Montageanleitung Außentreppe Scarvo

5) Montage

Schritt 11

Wenn die Handläufe verschraubt sind, werden die Kabelbinder entfernt und die Gewindestifte, die an den Stufenenden die Geländerstäbe halten, nachgezogen (Bild 1).



Schritt 12

Kürze den nach unten überstehenden Geländerstab mit einer Metallsäge oder einem Trennschleifer. Nach dem Versiegeln der Schnittstellen durch das beigelegte Zink-Alu Spray (24), treibe die Kunststoff-Rohrstopfen (20) in die Geländerstäbe von unten hinein.



Bohre im Anschluss mit dem beiliegendem Bohrer Ø5 mm (27) in jede Kunststoffkappe ungefähr mittig ein Loch. Werden die Löcher nicht gebohrt, können bei Minustemperaturen durch Gefrieren von Regenwasser Schäden an Geländerstab und Handlaufhalter entstehen.



Montageanleitung Außentreppe Scarvo

5) Montage

Schritt 13

Schiebe nun das Abschlussrohr (16) oben auf das Zentral-Standrohr und befestige dieses mit den Gewindestiften (5) (Bild 1). Anschließend klemme die Ronde (2) oben auf das Abschlussrohr (Bild 2).

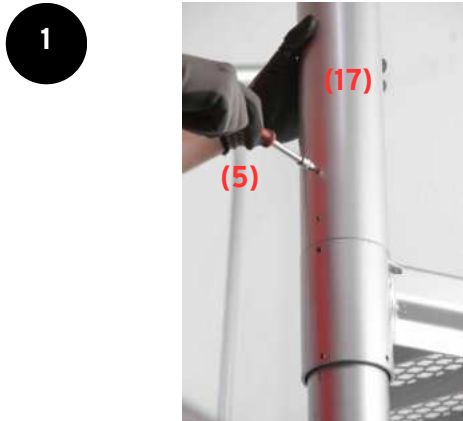

Schritt 14

Die Stufen, das Podest und das Abschlussrohr werden nun noch zusätzlich mit Spannhülsen (9) gesichert. Bohre dafür durch die vorgesehenen Löcher in den Stufen mit dem Bohrer ein $\text{\O}5$ mm Loch in das Zentral-Standrohr und treibe die Spannhülse ein.





Montageanleitung Außentreppe Scarvo

5) Montage

Schritt 15 (Stahl)

Nachdem du die Stufen, das Podest und das Abschlussrohr gesichert hast, wird nun das Geländer an dem Podest wie folgt montiert:

1. Löcher für die Sockel (7) vorbohren (Bild 1).
2. Mit dem Gewindebohrer (25) ein Gewinde in die Löcher schneiden.
3. Sechskantschraube (28) in den Sockel stecken und anschließend in die präparierten Löcher schrauben (Bild 2).
4. Geländerstäbe (15) mit dem Gewindestift befestigen.
5. Handlaufhalter (10) und Geländerstab (15) mit der Halbrundkopf-Schraube (11) verschrauben (Bild 3).

Bitte achte darauf, dass die Kröpfung der Handlaufhalter nicht nach außen, sondern zur Podest-Innenseite zeigen.

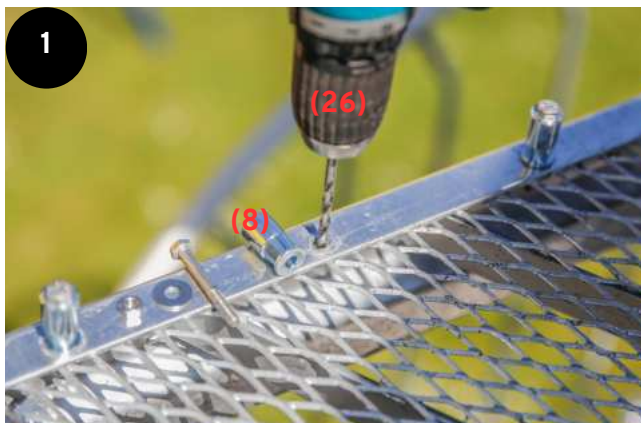

3





Montageanleitung Außentreppe Scarvo

5) Montage

Schritt 15 (WPC)

Nachdem du die Stufen, das Podest und das Abschlussrohr gesichert hast, wird nun das Geländer an dem Podest wie folgt montiert:

1. Löcher für die Sockel (8) vorbohren, 2 cm vom Rand (Bild 1).
2. Mit dem Gewindebohrer (26) ein Gewinde in die Löcher schneiden.
3. Sechskantschraube (29) in den Sockel stecken und anschließend in die präparierten Löcher schrauben (Bild 2).
4. Geländerstäbe (16) mit dem Gewindestift befestigen.
5. Handlaufhalter (11) und Geländerstab (16) mit der Halbrundkopf-Schraube (12) verschrauben (Bild 3).

Bitte achte darauf, dass die Kröpfung der Handlaufhalter nicht nach außen, sondern zur Podest-Innenseite zeigt.





Montageanleitung Außentreppe Scarvo

5) Montage

Schritt 16

Befestige nun den Handlauf. Als erstes bohre ein Ø5 mm Loch in das Abschlussrohr und schneide dort mit dem beigelegten Gewindebohrer (25) ein Gewinde (Bild 1). Stecke die Sechskantschraube (29) durch den Universalanschluss (14) und schraube diese in das vorgeschchnittene Gewinde (Bild 2).

Bohre ein 4 mm Loch durch Handlauf (13) und Universalanschluss (14) und verschraube diese mithilfe der mitgelieferten Linsenkopfschraube (11).



Bitte achte darauf, dass der Podesthandlauf (13) an der angrenzenden Wand oder dem angrenzenden Geländer befestigt wird. Bitte kontrolliere sämtliche Schraubverbindungen an der Treppe und ziehe diese gegebenenfalls nach.



Montageanleitung Außentreppe Scarvo

5) Montage

Schritt 17

Besprühe alle Stellen, an denen du die Spannhülsen eingetrieben hast bzw. die Gewindestifte eingedreht wurden, mit dem mitgelieferten Zinkspray (24). Überschüssige Verzinkungsreste auf den Gittern der Stufen können einfach mit einem Handfeger entfernt werden.



Daniel Gruppe GmbH

Daimlerstraße 17

32312 Lübbecke

Telefon 0 57 41 / 34 80 -40

E-Mail info@scalant.de



Instructions external staircase Scarvo

1) Required preliminary work

The foundation specifications correspond to normal ground conditions with natural soil.

Concrete material: Bn25

Frost-free foundation (approx. 80 cm) on natural soil.

Foundation dimensions:

	Ø 130	Ø 160	Ø 180	Ø 225
L	55x55x80 cm	55x55x80 cm	55x55x80 cm	55x55x80 cm
XL	55x55x80 cm	55x55x80 cm	60x60x80 cm	65x65x80 cm
XXL	55x55x80 cm	55x55x80 cm	65x65x80 cm	70x70x80 cm



















Tools for installing the outside staircase:

- (Impact) drill, cordless screwdriver
- Screwdriver (Torx)
- Allen wrench (e.g. Inbus) 3 mm, 4 mm, 5 mm
- Tape measure, calculator
- Hammer, combination pliers
- Screwdriver size 10 mm
- Spirit level
- Hacksaw
- Ladder



Instructions external staircase Scarvo

















2) Scarvo Outside Staircase parts list

#	Designation	Technical information	Illustration	
			Standard	premium
1.	Base plate with pipe sleeve			
2.	Round blank			
3.	Curved railing rod			
4.1.	Screw A2 semicircular head	6x25 mm		
4.2.	Countersunk screw	M6x16 mm		
5.	Grub screw	M8x8 mm		
6.	Handrail connector			
7.	Base for platform rod			
8.	Central support pipe			
9.	Clamping sleeve A2			
10.	Handrail holder			
11.	Screw A2 pan head	4,8x13 mm		
12.	Grub screw	M6x5 mm		
13.	Platform handrail			



Instructions external staircase Scarvo





2) Scarvo Outside Staircase parts list

#	Designation	Technical information	Illustration	
			Standard	premium
14.	Universal connection			
15.	Straight railing rod			
16.	End pipe top			
17.	Platforms			
18.	Steps			
19.	Screw A2 pan countersunk	4,8x16 mm		
20.	Railing rod pipe stopper	Ø20 mm		
21.	Handrail pipe elbow segment	Ø40 mm		
22.	Handrail pipe end plug	Ø40 mm		
23.	Bit	TORX 25		
24.	Zinc aluminum spray	400 ml		
25.	Screw tap	M6 mm		
26.	Cable tie	2,6x100 mm		
27.	Spiral drill	Ø 4 mm Ø 5 mm		



Instructions external staircase Scarvo

2) Scarvo Outside Staircase parts list

#	Designation	Technical information	Illustration	
			Standard	premium
28.	Hexagon screw A2	Stahl: M6x35 mm WPC: M6x60 mm		
29.	Hexagon screw A2	M6x50 mm		
30.	Grub screw	10x8 mm		
31.	Support pipe adapter			
32.	Support pipe reinforcer			



Instructions external staircase Scarvo

3) Calculation of step spacing

The step height must be calculated individually due to the different story heights. Measure story height H from the ground to the upper edge of the floor of the ceiling opening. Divide (:) story height H by the number of steps + platform.

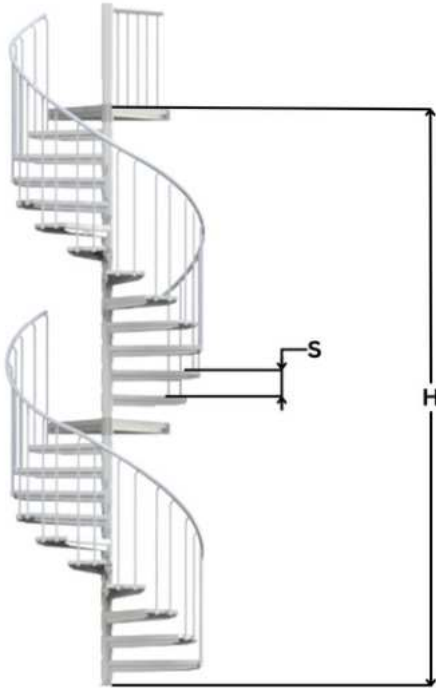

Example:

$$S = \frac{H}{\text{Number of steps} + \text{Number of platforms}}$$

$$S = \frac{252}{11 \text{ steps} + 1 \text{ platform}}$$

$$S = 21 \text{ cm}$$



The fixing material for assembling the platform to the building and fastening the base plate to the ground is not included.

Please check all screw connections on the spiral staircase at regular intervals.

No liability is accepted for damage caused by improper assembly.



Instructions external staircase Scarvo

4) Assembly of additional floors

Connection of support pipes

The Scarvo L to XXL spiral staircases include 2-4 support pipes. Depending on the type, the support pipes are connected to each other with a support pipe adapter (31) or a support pipe reinforcer (32). The support pipe adapter is inserted into the support pipe and fixed in place with the supplied grub screws (30). The support pipe extension is sunk into the support pipe as far as it will go so that the reinforcer protrudes about 150 mm from the support pipe. The support pipe reinforcer is also fixed in place with the grub screws (30).

If both support pipe reinforcers and support pipe adapters are included in the scope of delivery, use the support pipe reinforcers first and the support pipe adapters in the upper section of the staircase.

Sequence of assembly steps

The first part of the staircase is assembled according to the assembly instructions, skipping steps 13 and 15. Another support pipe has to be assembled now.

The second part of the staircase is assembled as described without steps 1-3 from the assembly instructions. (For the Scarvo L, assembly is complete here)

If the staircase is a Scarvo XL or XXL, steps 13 and 15 are also skipped in the second part of the staircase. The third support pipe is now attached.

The third staircase section is assembled again without steps 1-3 from the instructions. If it is a Scarvo XL, carry out all other steps in the assembly instructions. For a Scarvo XXL, also skip steps 13 and 15. The last support pipe is needed now. If the support pipe is fitted, assembly is done from step 4.

Note:

The supplied grub screws (pos. 30) for connecting the support pipes using the standpipe adapters / support pipe reinforcers should be tightened firmly, approx. 10-12 Nm.



Instructions external staircase Scarvo

4) Assembly of additional floors

Important information:

- To create a 360-degree turn, the upper staircase (from the intermediate platform to the upper platform) must be fitted with at least one additional step (12 steps, overlap = 0 cm).
- The step height should not be less than 17.5 cm (problem with the railing Ø).
- The platform does not necessarily have to be positioned exactly at the center of the staircase.
- With a maximum overlap of 2.3 cm, the upper section of the staircase (from the intermediate platform to the upper platform) must not contain more than 13 steps and one platform (14 total steps). With a step height of 23 (!) cm, the upper staircase reaches a maximum of 322 cm. If a greater height is required, more steps must be used, which increases the overlap of the steps.



Instructions external staircase Scarvo

5) Assembly

Step 1

Start by pouring the foundation. You will find the dimensions of the foundation for your staircase in the table above (page 22).

To pour the foundation at the correct distance from the wall, use the dimensions for your diameter from the table.

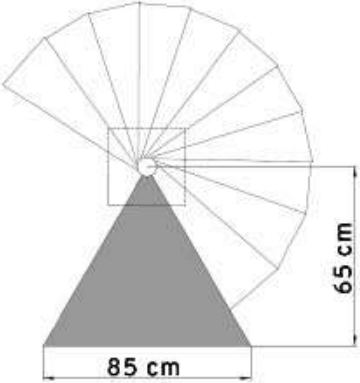
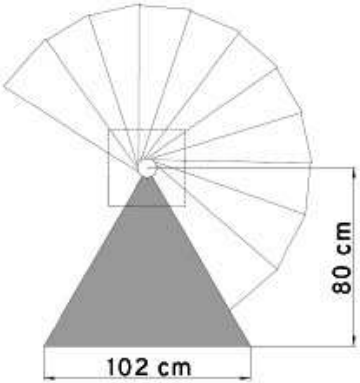
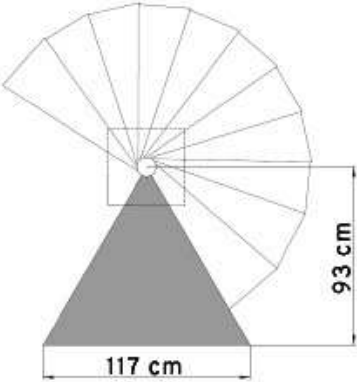
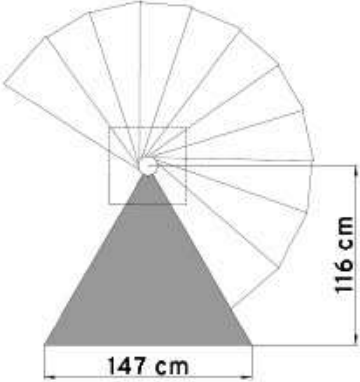
Ø 130 cm	Ø 160 cm
	
Ø 180 cm	Ø 225 cm
	



Instructions external staircase Scarvo

5) Assembly

Step 2

First the base plate is assembled. To drill the holes in the right places, place the base plate (1) on the foundation and trace the holes marked there with a pencil (fig. 1). When aligning the base plate, make sure the distance to the wall is correct. The table has the correct distances (Page 28).



Step 3

In the second step, the base plate (1) must be fixed to the foundation (fig. 1). Then place the central support pipe (8) on the base plate attached to the ground and secure it with the supplied grub screws (30) (fig. 2).

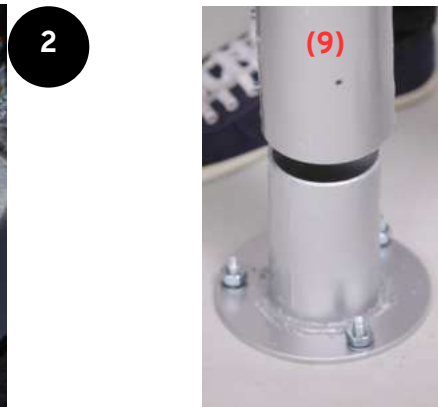



Instructions external staircase Scarvo

5) Assembly

Step 4

When the central support pipe is in place, you can start inserting the steps (18). To do this, simply slide the steps onto the support pipe on top of each other (fig. 1). To ensure better stability, use an aid such as a square timber and place the first step on top of it (fig. 2).

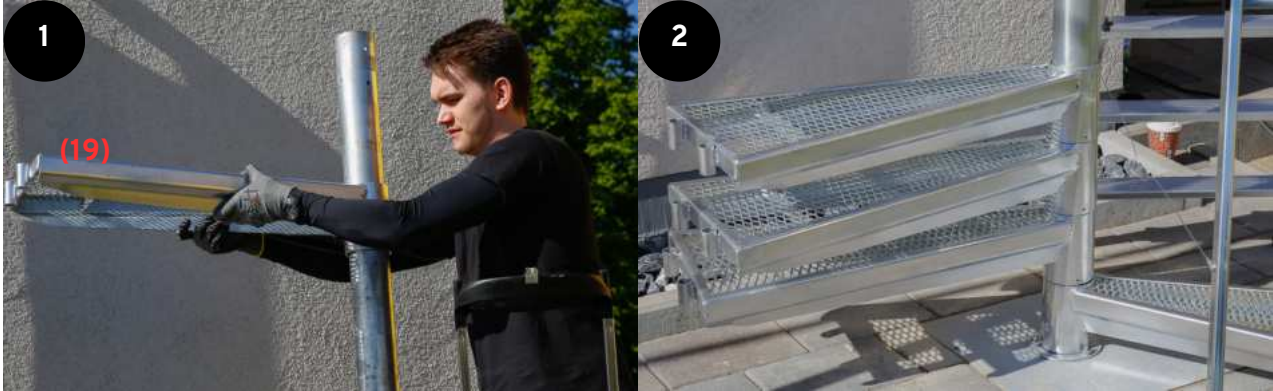

Step 5

Once all the steps have been inserted, the platform (17) can be mounted on the central support pipe. To do so, align the platform flush with the top edge of the finished floor and screw it to the wall (fig. 1). Then align the platform with a spirit level and fasten it to the central support tube. Use the supplied grub screws (4) (fig. 2). Please note that you have to use at least 10x60 mm key screws for a wooden ceiling and heavy-duty dowels for a concrete ceiling.





Instructions external staircase Scarvo

5) Assembly

Step 6

The individual step distances then have to be marked and the steps aligned. Orientation lines make it easier to align the steps at a later point. The step distance can be easily calculated: $\text{Story height } H / (11 \text{ steps} + 1 \text{ platform})$. Fastening a tape measure to the support pipe makes this much easier (fig. 1). Start with the first step from the top. Let the steps to overlap by 1 cm at the end of the step. Fasten the steps with the grub screws (5) (fig. 2). Do this for all steps.



Step 7

Now first insert the rear railing rods (3) into the railing holders at the end of the step (fig. 1). First fasten the rods with the grub screws (12) (fig. 2). The curve of the rods points in the opposite direction (seen from bottom to top).





Instructions external staircase Scarvo

5) Assembly

Step 8

Now insert the front railing rods, letting them protrude approx. 13 cm downwards.

Step 9

Screw the sections of the handrail holder (10) together with the screw (4). Then attach the handrail holder to the railing rods.

1



2



Step 10

Now place the curved handrail pipe segments (21) on the handrail holders and fasten them temporarily with the supplied cable ties (26) (fig. 1). Start from the bottom. Join the handrail segments together using the handrail connector (6) (Fig. 2).

1



2





Instructions external staircase Scarvo

5) Assembly

Now align the tabs parallel to the handrail by turning the ball into the rod. The angle of the tab can be changed by turning the rod (fig. 3).

Important: Check of the rods are vertical using a spirit level (fig. 4).

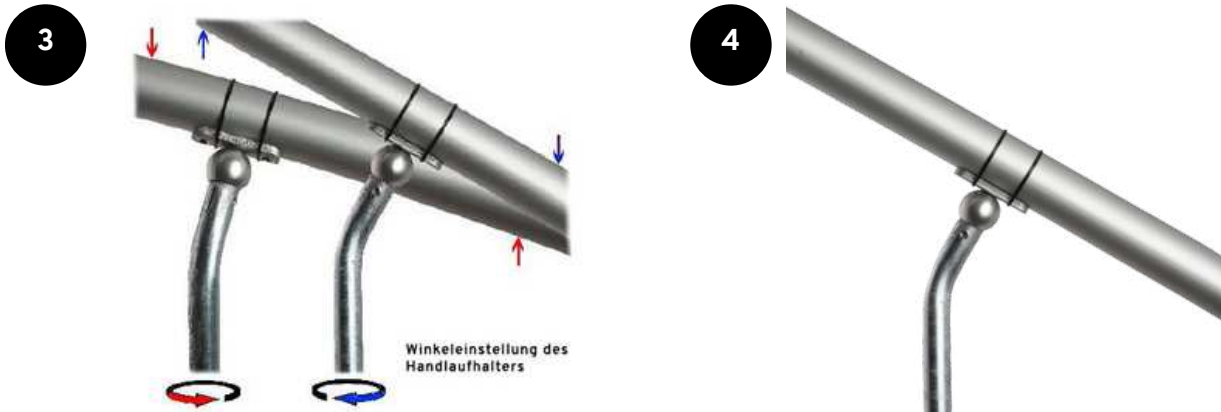

When these are aligned, screw the bracket to the railing rod using the flathead screw (11).

In the next step, mark the holes with a pencil and drill them into the handrail using the supplied $\text{Ø}4$ mm (27) drill bit. Then take the countersunk screws (19) and screw the handrail holder to the handrail pipe (Fig. 5).

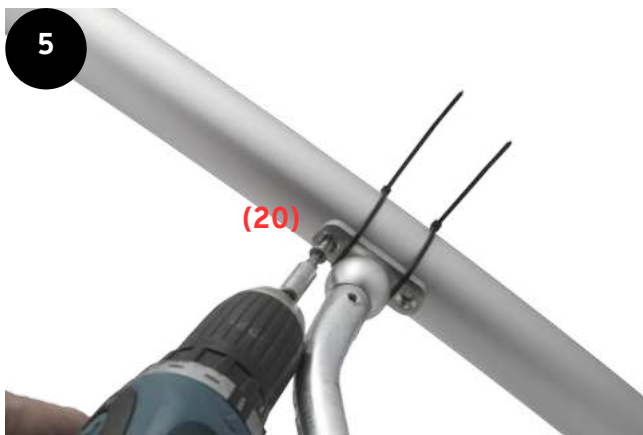



Instructions external staircase Scarvo

5) Assembly

Step 11

Once the handrails have been fastened, remove the cable ties and tighten the grub screws holding the railing rods at the step ends (fig. 1).



Step 12

Shorten the railing rod protruding downwards using a hacksaw or an angle grinder. After sealing the interfaces with the enclosed zinc aluminum spray (24), drive the plastic pipe stoppers (20) into the railing rods from below.



Then drill a hole roughly in the center of each plastic cap using the supplied Ø5 mm drill bit (27). If the holes are not drilled, freezing rainwater can damage the railing rods and handrail holders in sub-zero temperatures.



Instructions external staircase Scarvo

5) Assembly

Step 13

Now slide the end pipe (16) onto the top of the central support pipe and secure it with the grub screws (5) (fig. 1). Then clamp the round blank (2) onto the top of the end pipe (fig. 2).

1

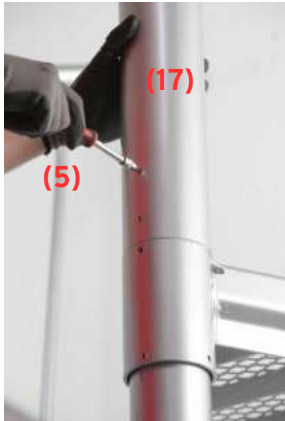

2



Step 14

Now also secure steps, the platform and the end tube with clamping sleeves (9). To do this, drill a $\text{Ø}5$ mm hole in the central upright support pipe through the holes provided in the steps using the drill and drive in the clamping sleeve.

1

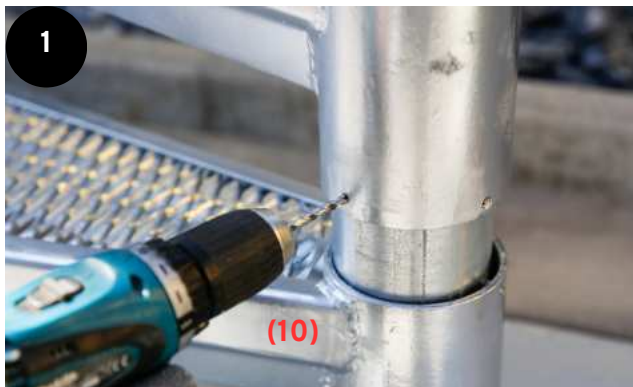

2





Instructions external staircase Scarvo

5) Assembly

Step 15 (steel)

After you have secured the steps, the platform and the end pipe, fasten the railing to the platform as follows:

1. Drill the holes for the bases (7) in advance (fig. 1).
2. Cut a thread in the holes using the screw tap (25).
3. Insert the hexagon screw (28) into the base and then screw it into the prepared holes (fig. 2).
4. Fix the railing rods (15) with the grub screw.
5. Screw the handrail holder (10) and railing rod (15) together with the semicircular head screw (11) (fig. 3).

Please make sure that the curve of the handrail holder does not point outwards, but towards the inside of the platform.

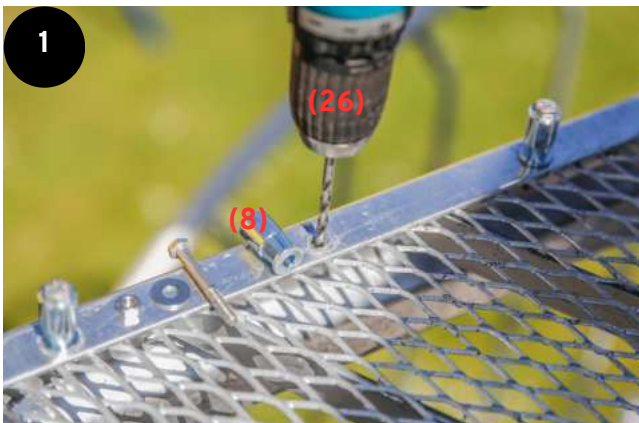

3





Instructions external staircase Scarvo

5) Assembly

Step 15 (WPC)

After you have secured the steps, the platform and the end pipe, fasten the railing to the platform as follows:

1. Drill the holes for the bases (7) 2 cm from the edge in advance (fig. 1)
2. Cut a thread in the holes using the screw tap (25).
3. Insert the hexagon screw (28) into the base and then screw it into the prepared holes (fig. 2).
4. Fix the railing rods (15) with the grub screw.
5. Screw the handrail holder (10) and railing rod (15) together with the semicircular head screw (11) (fig. 3).

Please make sure that the curve of the handrail holder does not point outwards, but towards the inside of the platform.

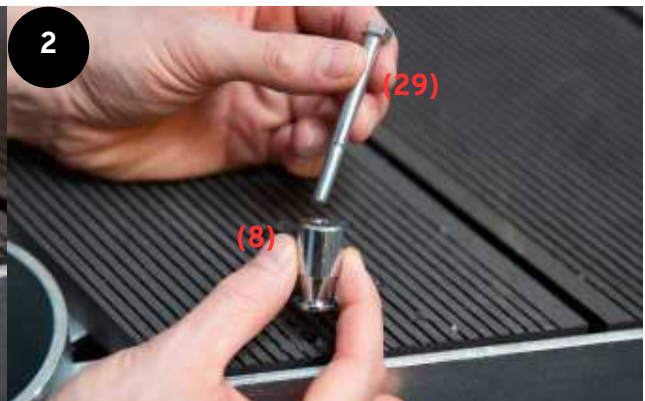



Instructions external staircase Scarvo

5) Assembly

Step 16

Now fasten the handrail. First, drill a $\varnothing 5$ mm hole in the end pipe and cut a thread there using the supplied screw tap (25) (fig. 1). Insert the hexagon screw (29) through the universal connection (14) and screw it into the pre-cut thread (fig. 2).

Drill a 4 mm hole through the handrail (13) and universal connection (14) and screw them together using the supplied pan head screw (11).



Please make sure that the platform handrail (13) is attached to the adjacent wall or railing. Please check all screw connections on the stairs and tighten if needed.



Instructions external staircase Scarvo

5) Assembly

Step 17

Spray all points where you have driven in the clamping sleeves or where the grub screws have been screwed in with the supplied zinc spray (24). Excess zinc residue on the step grates can be easily removed with a hand brush.



SCALANT is a brand of
Daniel Gruppe GmbH
Daimlerstraße 17
32312 Lübbecke
E-mail info@scalant.eu



Instructions d'installation escalier extérieur Scarvo

1) Préparatifs nécessaires

Les indications concernant la réalisation des fondations sont valables pour un sol normal, non remanié.

Qualité du béton : Bn25

Fondations hors gel (env. 80 cm de profondeur) sur sol non remanié.

Dimensions des fondations :

	Ø 130	Ø 160	Ø 180	Ø 225
L	55x55x80 cm	55x55x80 cm	55x55x80 cm	55x55x80 cm
XL	55x55x80 cm	55x55x80 cm	60x60x80 cm	65x65x80 cm
XXL	55x55x80 cm	55x55x80 cm	65x65x80 cm	70x70x80 cm

Outillage nécessaire au montage de l'escalier extérieur :

- Outillage nécessaire au montage de l'escalier extérieur :
- Perceuse à percussion, visseuse sans fil
- Tournevis (Torx)
- Clés pour vis à six pans creux (type Inbus, p. ex.) 3 mm, 4 mm, 5 mm
- Mètre ruban, calculatrice
- Marteau, pince universelle
- Clé de serrage 10 mm
- Niveau à bulle
- Scie à métaux
- Escabeau















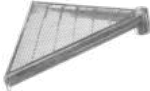

Instructions d'installation escalier extérieur Scarvo

2) Liste des pièces pour l'escalier extérieur Scarvo

#	Désignation	Infos techniques	Illustration	
			Standard	Premium
1.	Pied avec emmanchement pour tube			
2.	Couvercle			
3.	Main-courante coudée			
4.1.	Vis à tête demi-ronde A2	6x25 mm		/
4.2.	Vis à tête fraisée	M6x16 mm		
5.	Vis sans tête	M8x8 mm		
6.	Raccord pour main-courante			
7.	Douille support de palier			
8.	Colonne centrale verticale			
9.	Goupille de serrage A2			
10.	Support de main-courante			
11.	Vis à tête bombée A2	4,8x13 mm		
12.	Vis sans tête	M6x5 mm		
13.	Main-courante de palier			





2) Liste des pièces pour l'escalier extérieur Scarvo

#	Désignation	Infos techniques	Illustration	
			Standard	Premium
14.	Connecteur universel			
15.	Main-courante droite			
16.	Tube de fermeture haut			
17.	Palier avec grille métallique			
18.	Marche avec grille métallique			
19.	Vis à tête fraisée A2	4,8x16 mm		
20.	Embout pour tube de main-courante	Ø20 mm		
21.	Section de main-courante cintrée	Ø40 mm		
22.	Bouchon pour tube de main-courante	Ø40 mm		
23.	Embout	TORX 25		
24.	Pulvérisateur Alu-Zinc	400 ml		
25.	Taraud	M6 mm		
26.	Collier de serrage	2,6x100 mm		



2) Liste des pièces pour l'escalier extérieur Scarvo

#	Désignation	Infos techniques	Illustration	
			Standard	Premium
27.	Foret hélicoïdal	Ø 4 mm Ø 5 mm		
28.	Vis à tête hexagonale A2	Stahl: M6x35 mm WPC: M6x60 mm		
29.	Vis à tête hexagonale A2	M6x50 mm		
30.	Vis sans tête	10x8 mm		
31.	Adaptateur pour colonne centrale			
32.	Renforceur de colonne			



Instructions d'installation escalier extérieur Scarvo

3) Calcul des hauteurs de marche

La hauteur des niveaux d'un bâtiment étant spécifique, la hauteur des marches doit être calculée individuellement. Mesurer la hauteur de niveau H entre le sol et le bord supérieur de l'ouverture pratiquée dans le plafond. Diviser la hauteur H par le nombre de marches + palier.

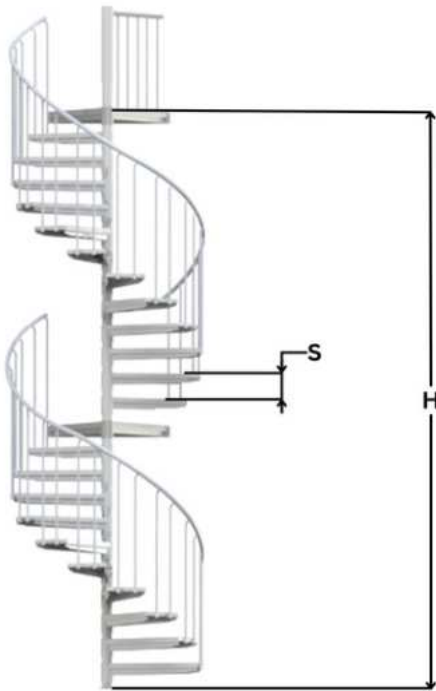

Exemple:

$$S = \frac{H}{\text{Number of steps} + \text{Nombre de paliers}}$$
$$S = \frac{252}{11 \text{ marches} + 1 \text{ palier}}$$
$$S = 21 \text{ cm}$$



Les fournitures nécessaires pour fixer le palier au bâtiment et pour fixer la plaque de base dans le sol ne sont pas incluses.

Contrôler régulièrement tous les raccords vissés présents sur l'escalier hélicoïdal.

Nous refusons toute mise en cause de notre responsabilité en cas de dommages causés par un montage non conforme.



4) Assemblage d'étages supplémentaires

Relier les colonnes centrales

Les escaliers à colimaçon Scarvo des dimensions L à XXL comportent 2 à 4 colonnes centrales. Selon la version, la liaison entre ces colonnes centrales est réalisée au moyen d'un adaptateur (31) ou d'un renfort (32). L'adaptateur est enfiché dans la colonne centrale et fixé au moyen des vis sans tête (30) fournies. Insérer le tube de rallonge dans la colonne centrale jusqu'à la butée, de sorte que le renfort dépasse encore de la colonne centrale d'environ 150 mm. Le renfort pour colonne centrale est également fixé à l'aide des vis sans tête fournies (30).

Si le matériel est fourni avec des renforts de colonne centrale et des adaptateurs, utiliser en premier lieu le renfort, et réserver l'adaptateur à la partie supérieure de l'escalier.

Étapes du montage

La première partie de l'escalier doit être assemblée selon les instructions du manuel, en sautant les étapes 13 et 15. Il convient à présent de monter une deuxième colonne centrale.

La deuxième partie de l'escalier s'assemble selon la description donnée, en omettant les étapes 1 à 3 du manuel. Pour le modèle Scarvo L, les étapes d'assemblage sont exclues.

Pour un escalier du modèle Scarvo XL ou XXL, les étapes 13 et 15 ne sont pas non plus applicables au montage de la deuxième partie de l'escalier. Présenter maintenant la troisième colonne centrale.

L'assemblage de la troisième partie de l'escalier s'effectue de nouveau en sautant les étapes 1 à 3 du manuel. Pour le modèle Scarvo XL, suivre toutes les autres étapes du manuel d'assemblage. Pour le modèle Scarvo XXL, ne pas appliquer non plus les étapes 13 et 15. Vous aurez à présent besoin de la dernière colonne centrale. Une fois la colonne centrale fixée, effectuer le montage à partir de l'étape 4.

Remarque:

Les vis sans tête fournies (30) permettant de fixer les colonnes centrales au moyen d'adaptateurs/de renforts doivent être bien serrées, selon un couple indicatif de 10 à 12 Nm.



4) Assemblage d'étages supplémentaires

Important à cette étape:

- Pour obtenir une rotation de 360 degrés, l'escalier supérieur (du palier intermédiaire au palier supérieur) doit être monté avec au moins une marche supplémentaire (12 marches, chevauchement = 0 cm).
- La hauteur des marches ne doit pas être inférieure à 17,5 cm (problème concernant le Ø de la main courante).
- Le palier ne doit pas nécessairement être positionné exactement à mi-hauteur.
- Avec un chevauchement de 2,3 cm maximum, la partie supérieure de l'escalier (du palier intermédiaire au palier le plus haut) peut comporter au maximum 13 marches et un palier (14 élévations). Pour une hauteur d'élévation de 23 (!) cm, on atteint ainsi 322 cm au maximum avec l'escalier supérieur. Pour atteindre une hauteur plus importante, il faut utiliser plus de marches, et donc augmenter le chevauchement des marches.



5) Montage

Étape 1

Commencer par couler la fondation. Le tableau (page 41) indique les dimensions de la fondation à réaliser en fonction du type d'escalier. Pour couler la fondation à bonne distance du mur du bâtiment, utiliser les dimensions correspondant au diamètre d'escalier fournies dans le tableau.

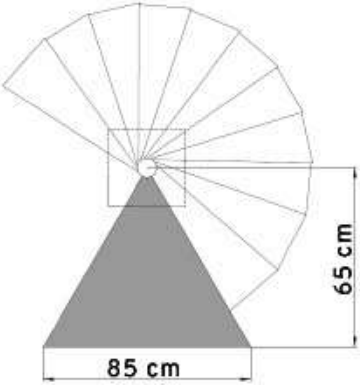
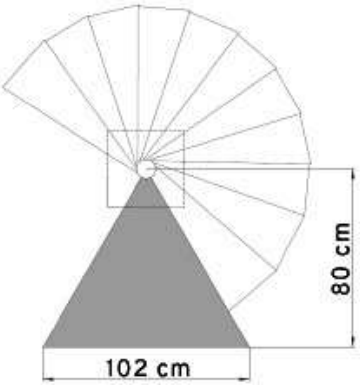
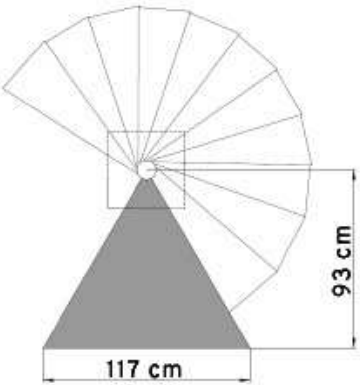
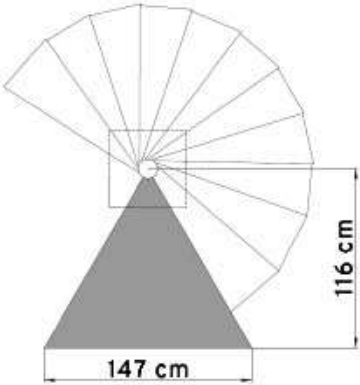
Ø 130 cm	Ø 160 cm
	
Ø 180 cm	Ø 225 cm
	



Instructions d'installation escalier extérieur Scarvo

5) Montage

Étape 2

Fixer la plaque de base. Afin de percer les trous aux bons endroits, positionner la plaque de base (1) sur la fondation et marquer les trous au crayon aux emplacements prévus (figure 1). Pour aligner la plaque de base, vérifier la distance par rapport au mur du bâtiment. Le tableau indique les distances adaptées (Page 48).



Étape 3

La deuxième étape consiste à fixer la plaque de base (1) à la fondation (figure 1). Ensuite, positionner la colonne centrale verticale (8) sur la plaque de base fixée au sol et la fixer avec les vis sans tête fournies (30) (figure 2).

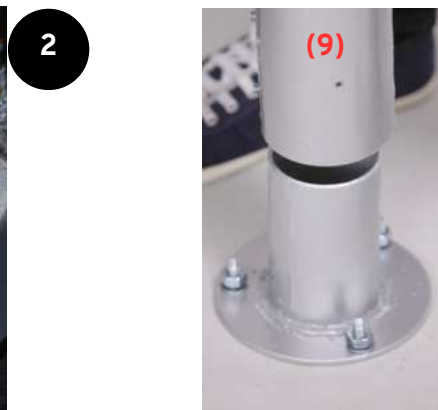



Instructions d'installation escalier extérieur Scarvo

5) Montage

Étape 4

Lorsque la colonne centrale est en place, commencer à enfiler les marches (18). Faire glisser les marches sur la colonne centrale les unes au-dessus des autres (figure 1). Pour assurer une meilleure stabilité, utiliser par exemple une pièce de bois équarrie sur laquelle vous placerez la première marche (figure 2).

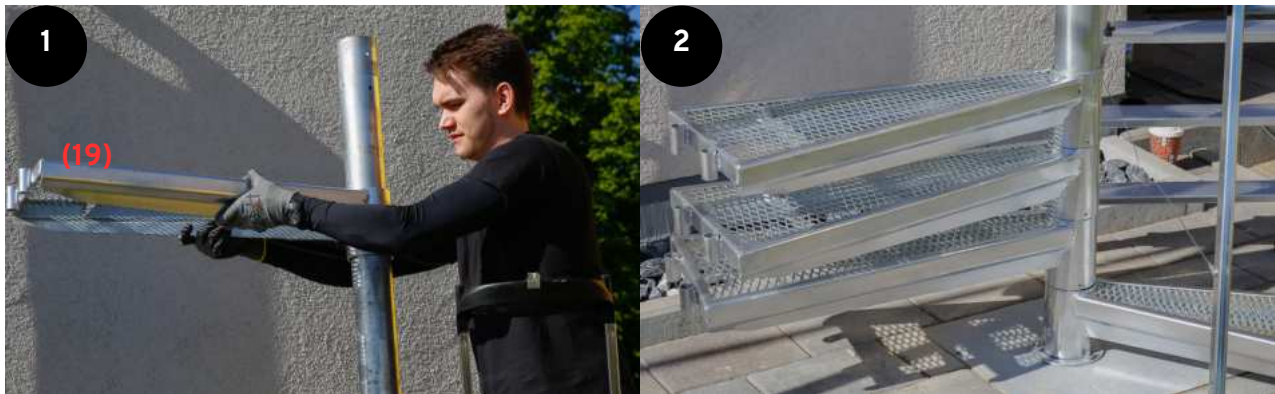

Étape 5

Quand toutes les marches sont positionnées, monter le palier (17) sur la colonne centrale. Pour ce faire, aligner le palier au ras du bord supérieur du plancher fini, avant de le visser au mur (figure 1). Ensuite, aligner le palier avec un niveau à bulle avant de le fixer à la colonne centrale. Utiliser pour cela les vis sans têtes (5) fournies (figure 2). Vous devez utiliser des vis d'au moins 10x60 mm pour la fixation dans un plafond en bois et des chevilles haute résistance pour la fixation dans une dalle en béton.





Instructions d'installation escalier extérieur Scarvo

5) Montage

Étape 6

Ensuite, marquer l'écartement entre les marches et aligner les marches. Les repères d'orientation facilitent l'alignement ultérieur des marches. L'écartement entre les marches peut être déterminé facilement : Hauteur H / (11 marches + 1 palier). Pour faciliter l'opération, fixer un mètre ruban sur la colonne centrale (figure 1). Commencer par la première marche en partant du haut. Les marches doivent se chevaucher sur 1 cm en bout de marche. Fixer les marches à l'aide des vis sans tête (5) (figure 2). Procéder de la même manière pour toutes les marches.



Étape 7

Commencer par insérer les tiges arrière du garde-corps (3) dans les supports de garde-corps positionnés en bout de marche (figure 1). Fixer ensuite les tiges à l'aide des vis sans tête (12) (figure 2). Le déport des tiges pointe dans la direction opposée au sens de marche (vu de bas en haut).

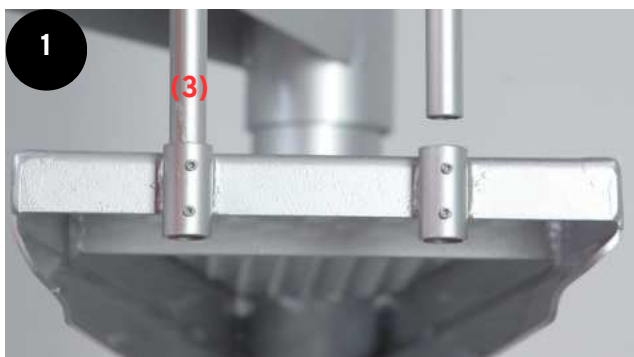



Instructions d'installation escalier extérieur Scarvo

5) Montage

Étape 8

Insérer maintenant les tiges avant du garde-corps et en les laissant dépasser d'environ 13 cm vers le bas.

Étape 9

Fixer les éléments des supports de main-courante (10) avec les vis (4). Ensuite, insérer les supports de main-courante sur les tiges du garde-corps.



Étape 10

Placer maintenant les sections de main-courante cintrées (21) sur les supports de main-courante avant de les fixer provisoirement avec les colliers de serrage (26) fournis (figure 1). Commencer par le bas. Utiliser les raccords pour main-courante (6) pour assembler les sections de main-courante (figure 2).

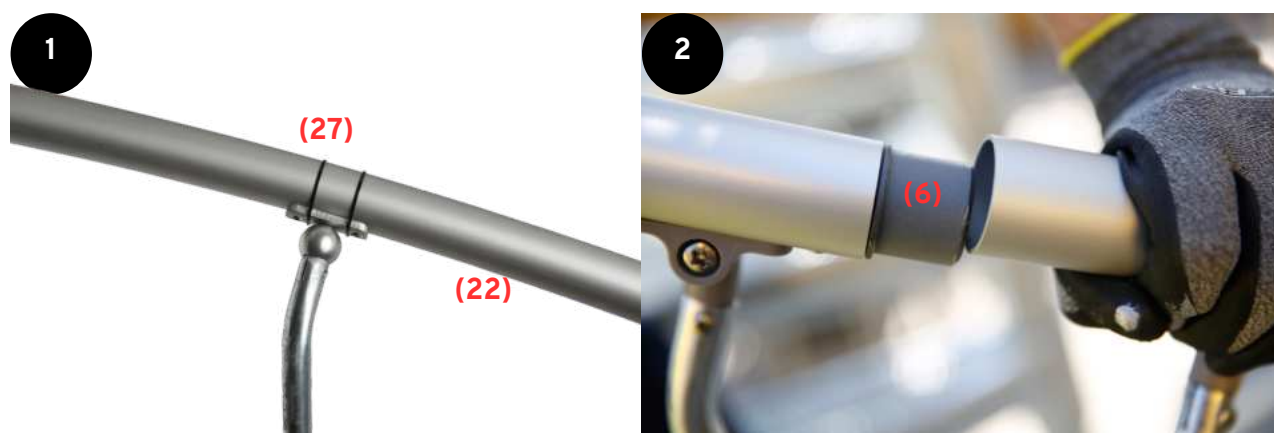



Instructions d'installation escalier extérieur Scarvo

5) Montage

Orienter les pattes parallèlement à la main-courante en tournant la sphère dans la tige. Tourner la tige permet de modifier l'angle de la patte (figure 3).

Important : Utiliser un niveau à bulle pour aligner verticalement les tiges de garde-corps (figure 4).

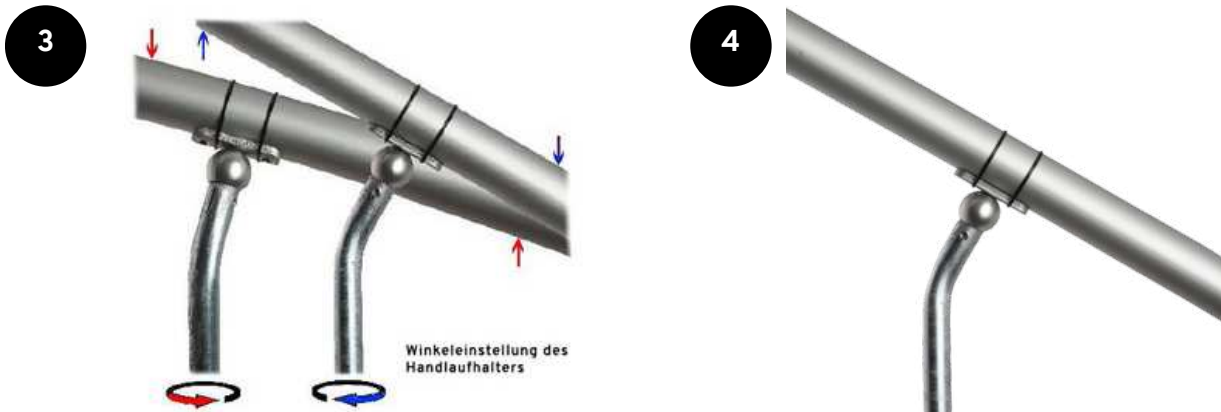

Une fois la verticalité contrôlée, visser les supports aux tiges de garde-corps à l'aide des vis à tête plate (11).

Marquer les trous à l'aide d'un crayon et percer la main-courante à l'aide du foret de Ø 4 mm (27) fourni. Ensuite, prendre les vis à tête fraisée (19) pour visser le support de main-courante au tube de main-courante (figure 5).





5) Montage

Étape 11

Une fois la main-courante vissée, enlever les colliers de serrage-câbles et serrer les vis sans tête pour fixer les tiges de garde-corps en bout de marche (figure 1).



Étape 12

Raccourcir la partie des tiges de garde-corps qui dépasse vers le bas à l'aide d'une scie à métaux ou d'une meuleuse de découpe. Après avoir protégé les découpes à l'aide du pulvérisateur zinc-aluminium (24) fourni, insérer les bouchons en plastique (20) dans les tiges de garde-corps, par le bas.



Ensuite, percer un trou à peu près au centre de chaque bouchon en plastique à l'aide du foret de Ø 5 mm fourni (27). Si les trous ne sont pas percés, l'eau de pluie peut s'accumuler dans les tiges de garde-corps et les supports de main-courante et les endommager en cas de gel.



Instructions d'installation escalier extérieur Scarvo

5) Montage

Étape 13

Insérer maintenant le tube de fermeture (16) sur le haut de la colonne centrale avant de le fixer à l'aide des vis sans tête (5) (figure 1). Ensuite, placer le couvercle (2) sur l'extrémité du tube de fermeture (figure 2).

1

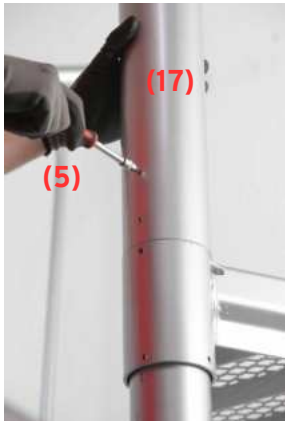

2



Étape 14

Il convient à présent de parfaire la fixation des marches, du palier et du tube de fermeture à l'aide de manchons de serrage (9). Percer un trou de \varnothing 5 mm dans la colonne centrale à travers les trous prévus dans les marches à l'aide du foret, puis insérer la goupille de serrage.

1



2





5) Montage

Étape 15 (acier)

Après avoir fixé les marches, le palier et le tube de fermeture, il convient d'assembler le garde-corps sur le palier :

1. Pré-percer des trous pour les douilles (7) (figure 1).
2. Fileter les trous percés à l'aide du taraud (25).
3. Insérer les vis à tête hexagonale (28) dans les douilles avant de les visser dans les trous préparés (figure 2).
4. Fixer les tiges du garde-corps (15) à l'aide de vis sans tête.
5. Visser les supports de main-courante (10) et les tiges de garde-corps (15) avec des vis à tête demi-ronde (11) (figure 3).

Vérifier que le coude de fixation à la main-courante ne pointe pas vers l'extérieur, mais bien vers l'intérieur du palier.

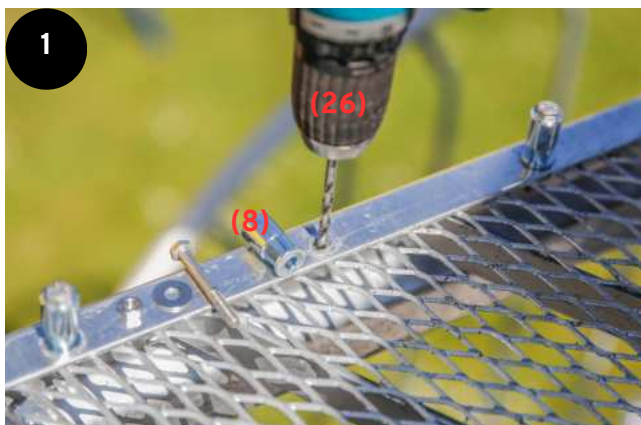

3





5) Montage

Étape 15 (WPC)

Après avoir fixé les marches, le palier et le tube de fermeture, il convient d'assembler le garde-corps sur le palier :

1. Pré-percer des trous pour les douilles (7), à 2 cm du bord (figure 1).
2. Fileter les trous percés à l'aide du taraud (25).
3. Insérer les vis à tête hexagonale (28) dans les douilles avant de les visser dans les trous préparés (figure 2).
4. Fixer les tiges du garde-corps (15) à l'aide de vis sans tête.
5. Visser les supports de main-courante (10) et les tiges de garde-corps (15) avec des vis à tête demi-ronde (11) (figure 3).

Vérifier que le coude de fixation à la main-courante ne pointe pas vers l'extérieur, mais bien vers l'intérieur du palier.

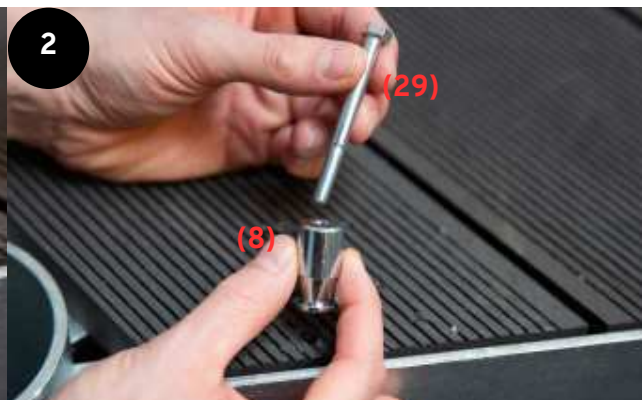



5) Montage

Étape 16

À présent, fixer la main-courante. Commencer par percer un trou de Ø 5 mm dans le tube de fermeture et réaliser un filetage à l'aide du taraud (25) fourni (figure 1). Insérer la vis à tête hexagonale (29) à travers le connecteur universel (14) pour la visser dans le filetage préparé dans le tube (figure 2).

Percer un trou de Ø 4 mm dans la main-courante (13) et le connecteur universel (14) et assembler ces éléments à l'aide de la vis à tête bombée (11) fournie.



La main-courante du palier (13) doit être fixée au mur ou au garde-corps. Contrôler tous les raccords vissés de l'escalier et resserrer si nécessaire.



5) Montage

Étape 17

À l'aide du pulvérisateur (24) fourni, appliquer un film de zinc-aluminium à chaque point d'insertion d'une goupille ou d'une vis sans tête. Les éventuels résidus de zinc pulvérisés sur les grilles des marches peuvent être facilement éliminés à l'aide d'une brosse à main.



SCALANT une marque de la société

Daniel Gruppe GmbH

Daimlerstraße 17

D-32312 Lübbecke

Téléphone +33 644 68 71 11

E-mail info@scalant.fr



1) Trabajos previos necesarios

Las especificaciones de los cimientos corresponden a las condiciones normales del terreno con suelo natural.

Material de hormigón: Bn25

Cimentación libre de heladas (aprox. 80 cm) sobre suelo natural.

Dimensiones de los cimientos:

	Ø 130	Ø 160	Ø 180	Ø 225
L	55x55x80 cm	55x55x80 cm	55x55x80 cm	55x55x80 cm
XL	55x55x80 cm	55x55x80 cm	60x60x80 cm	65x65x80 cm
XXL	55x55x80 cm	55x55x80 cm	65x65x80 cm	70x70x80 cm

Accesorios para la instalación de la escalera exterior:

- Taladro (percutor), atornillador de batería
- Destornillador (Torx)
- Llave hexagonal interior (por ejemplo, llave Allen) de 3 mm, 4 mm, 5 mm
- Cinta métrica, calculadora de bolsillo
- Martillo, alicates
- Llave SW10 mm
- Nivel de burbuja
- Sierra de metal
- Escalera



2) Lista de piezas - escalera exterior Scarvo

#	Denominación	Información técnica	Ilustración	
			Estándar	Premium
1.	Placa base con manguito de tubo			
2.	Tapa redonda			
3.	Barandilla acodada			
4.1.	Tornillo A2 de cabeza semicircular	6x25 mm		
4.2.	Tornillo avellanado	M6x16 mm		
5.	Tornillo prisionero	M8x8 mm		
6.	Conector de pasamanos			
7.	Base para varilla de rellano			
8.	Tubo de soporte central			
9.	Manguito de sujeción A2			
10.	Soporte de pasamanos			
11.	Tornillo A2 de cabeza lenticular	4,8x13 mm		
12.	Tornillo prisionero	M6x5 mm		



2) Lista de piezas - escalera exterior Scarvo

#	Denominación	Información técnica	Ilustración	
			Estándar	Premium
13.	Pasamanos de rellano			
14.	Conector universal			
15.	Barandilla recta			
16.	Tubo de extremo superior			
17.	Rellanos con rejilla encajable			
18.	Escalones con rejilla encajable			
19.	Tornillo A2 de cabeza avellanada	4,8x16 mm		
20.	Tapón para barra de barandilla	Ø20 mm		
21.	Segmento de tubo de pasamanos	Ø40 mm		
22.	Tapón final de tubo de pasamanos	Ø40 mm		
23.	Punta	TORX 25		
24.	Aerosol de zinc-aluminio	400 ml		
25.	Terraaja	M6 mm		



2) Lista de piezas - escalera exterior Scarvo

#	Denominación	Información técnica	Ilustración	
			Estándar	Premium
26.	Brida para cables	2,6x100 mm		
27.	Broca espiral	Ø 4 mm Ø 5 mm		
28.	Tornillo hexagonal A2	Stahl: M6x35 mm WPC: M6x60 mm		
29.	Tornillo hexagonal A2	M6x50 mm		
30.	Tornillo prisionero	10x8 mm		
31.	Adaptador para tubo de soporte			
32.	Refuerzo para tubo de soporte			



3) Cálculo de la distancia entre escalones

Debido a las diferentes alturas de los pisos, la altura del escalón debe calcularse individualmente. Mida la altura del piso H desde el suelo hasta el borde superior del suelo de la abertura del techo. Divida (:) la altura del piso H por el número de peldaños + rellano.

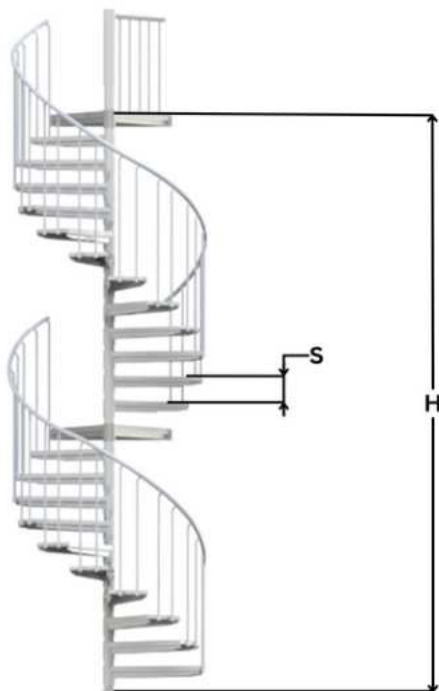

Ejemplo:

$$S = \frac{H}{\text{Número de escalones} + \text{Número de rellanos}}$$

$$S = \frac{252}{11 \text{ Escalones} + 1 \text{ rellano}}$$

$$S = 21 \text{ cm}$$



El material de fijación para montar el rellano en el edificio y para montar la placa base en el suelo no está incluido.

Compruebe periódicamente todas las uniones atornilladas de la escalera de caracol.

No se acepta ninguna responsabilidad por daños causados por una instalación incorrecta.



4) Montaje de más plantas

Unión de los tubos de soporte

Las escaleras de caracol Scarvo L a XXL incluyen 2-4 tubos de soporte. Los tubos de soporte se unen entre sí, dependiendo de la variante, con un adaptador para tubo de soporte (31) o un refuerzo para tubo de soporte (32). El adaptador para tubo de soporte se inserta en el tubo de soporte y se fija con los tornillos prisioneros (30) que se suministran. La prolongación del tubo de soporte se introduce hasta el tope en el tubo de soporte, de modo que el refuerzo sobresalga todavía unos 150 mm del tubo de soporte. El refuerzo del tubo de soporte también se fija con los tornillos prisioneros (30).

Si en el volumen de suministro se incluyen tanto refuerzos como adaptadores para tubo de soporte, utilice en primer lugar los refuerzos y después los adaptadores en la parte superior de la escalera.

Orden de los pasos de montaje

La primera parte de la escalera se realiza según las instrucciones de montaje. Para ello, se saltan los pasos 13 y 15. Ahora hay que montar otro tubo de soporte.

La segunda de la escalera se monta como se describe, sin realizar los pasos 1-3 de las instrucciones de montaje. (En el caso de la Scarvo L, el montaje finaliza aquí)

Si la escalera es una Scarvo XL o XXL, en la segunda parte de la escalera también se saltan los pasos 13 y 15. Ahora se agrega el tercer tubo de soporte.

La construcción de la tercera parte de la escalera se realiza de nuevo sin los pasos 1-3 de las instrucciones. Si se trata de un Scarvo XL, siga todos los pasos de las instrucciones de montaje. Para un Scarvo XXL, deben saltarse de nuevo los pasos 13 y 15. Ahora se necesita el último tubo de soporte. Después de fijar el tubo de soporte, el montaje se continúa a partir del paso 4.

Nota:

Los tornillos prisioneros suministrados (30) para la conexión de los tubos de soporte mediante el adaptador de tubo vertical/refuerzo de tubo vertical deben apretarse firmemente, aprox. a 10-12 Nm.



4) Montaje de más plantas

Para ello, es importante tener en cuenta:

- Para conseguir una vuelta de 360 grados, la escalera superior (desde el rellano intermedio hasta el rellano superior) debe montarse con al menos un escalón adicional (12 escalones, solapamiento = 0 cm).
- La altura del escalón no debe ser menor de 17,5cm (problema con el diám. de la barandilla).
- No es obligatorio que el rellano se posicione exactamente a media altura.
- Con un solapamiento de un máx. de 2,3 cm, solo puede haber en la parte superior de la escalera (desde el rellano intermedio hasta el rellano superior) un máximo de 13 escalones y un rellano (14 pasos de subida). Con una altura paso de 23 (!) cm se llega a una altura máxima de 322 cm con la escalera superior. Si se necesita alcanzar una altura superior, se tienen que emplear más escalones, con lo que aumenta el solapamiento de los escalones.



5) Montaje

Paso 1

Empiece por echar los cimientos. Encontrará las dimensiones de los cimientos de su escalera en la tabla anterior (pág. 60).

Para verter los cimientos a la distancia correcta de la pared, tome las dimensiones de su diámetro de la tabla.

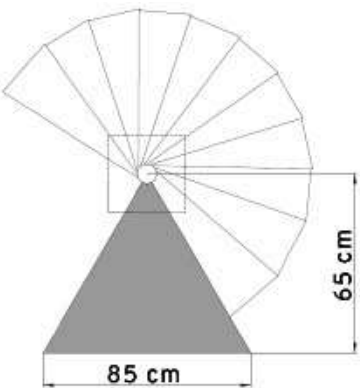
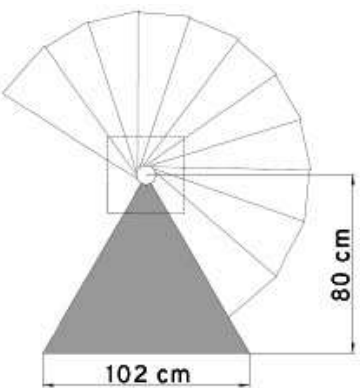
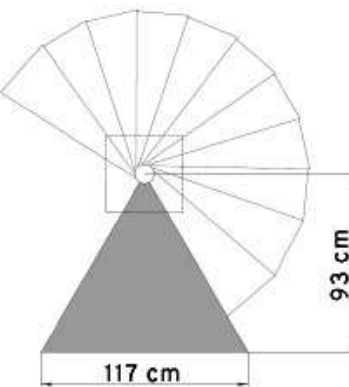
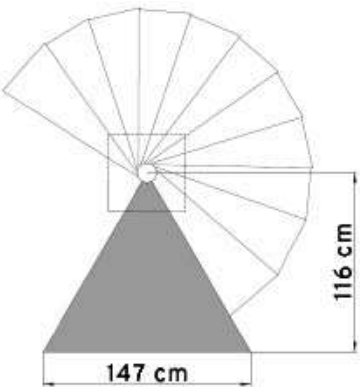
Ø 130 cm	Ø 160 cm
	
Ø 180 cm	Ø 225 cm
	



5) Montaje

Paso 2

En primer lugar se monta la placa base. Para taladrar los orificios en los lugares correctos, debe colocarse la placa base (1) sobre los cimientos y marcar los orificios predefinidos con un lápiz (fig. 1). Al alinear la placa base, debe respetarse la distancia correcta a la pared. Consulte la tabla para conocer las distancias adecuadas (pág. 67).



Paso 3

En el segundo paso, la placa base (1) debe fijarse a los cimientos (fig. 1). A continuación, coloque el tubo de soporte central (8) sobre la placa base fijada al suelo y fíjelo con los tornillos prisioneros (30) que se suministran (fig. 2).

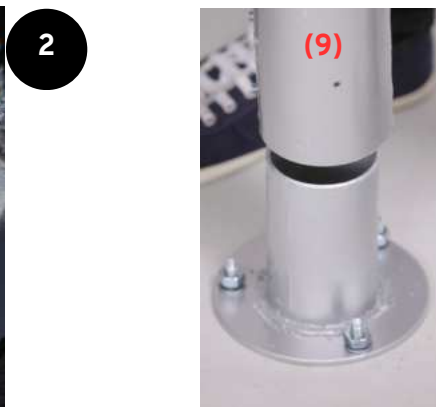



5) Montaje

Paso 4

Una vez colocado el tubo de soporte central, puede empezar a colocar los peldaños (18) de abajo arriba. Para ello, basta con deslizar los peldaños unos sobre otros en el tubo de soporte (fig. 1). Para garantizar una mayor estabilidad, utilice un accesorio como, por ejemplo, un cuadradillo de madera y coloque el primer peldaño sobre el cuadradillo (fig. 2).

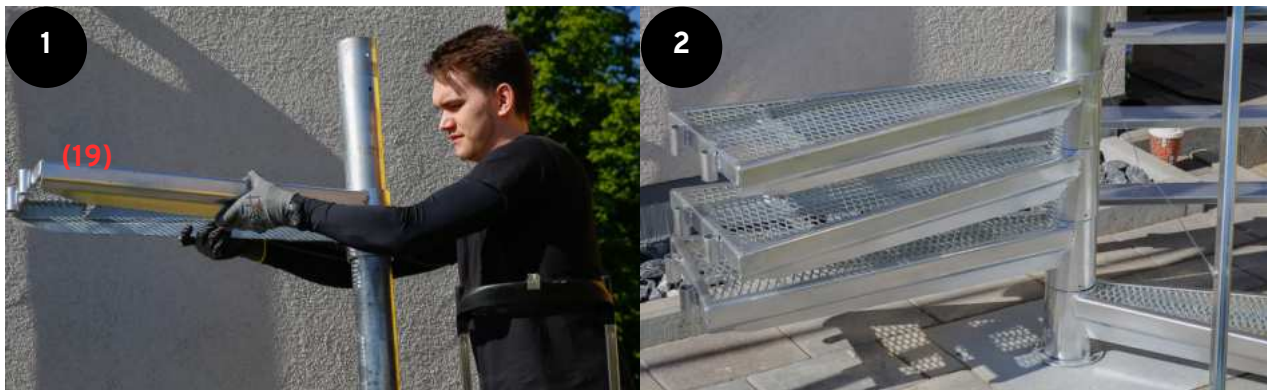

Paso 5

Una vez insertados todos los peldaños, se puede montar el rellano (17) en el tubo de soporte central. Para ello, alinee el rellano a ras con el borde superior del suelo acabado y atorníllelo a la pared (fig. 1). A continuación, nivele el rellano con un nivel de burbuja y fíjelo al tubo de soporte central. Utilice para ello los tornillos prisioneros (5) suministrados (fig. 2). Tenga en cuenta que debe utilizar como mínimo tornillos de 10x60 mm para un techo de madera y tacos para cargas pesadas para un techo de hormigón.





5) Montaje

Paso 6

A continuación, hay que marcar las distancias entre los escalones y alinearlos. Las líneas de orientación facilitan la posterior alineación de los peldaños. La distancia entre peldaños se puede determinar fácilmente: $\text{Altura del piso } H / (11 \text{ peldaños} + 1 \text{ rellano})$. Fijar una cinta métrica al tubo de soporte facilita mucho el trabajo (fig. 1). Comience con el primer escalón desde arriba. Deje que los peldaños se solapen 1 cm al final del peldaño. Fije los peldaños con los tornillos prisioneros (5) (fig. 2). Realice este paso con todos los peldaños.



Paso 7

A continuación, introduzca primero las varillas de la barandilla trasera (3) en los soportes para la barandilla situados al final del escalón (fig. 1). Fije primero las varillas con los tornillos prisioneros (12) (fig. 2). La curva de las varillas apunta en sentido contrario al de marcha (visto de abajo hacia arriba).





5) Montaje

Paso 8

Introduzca ahora las varillas de la barandilla delantera y deje que sobresalgan unos 13 cm hacia abajo.

Paso 9

Atornille las piezas del soporte del pasamanos (10) con el tornillo (4). A continuación, fije el soporte del pasamanos a las varillas de la barandilla.



Paso 10

Coloque ahora los segmentos de tubo del pasamanos (21) en los soportes del pasamanos y fíjelos provisionalmente con las bridas para cables (26) suministradas (fig. 1). Empiece por la parte inferior. Una los segmentos del pasamanos con los conectores (6) (fig. 2).

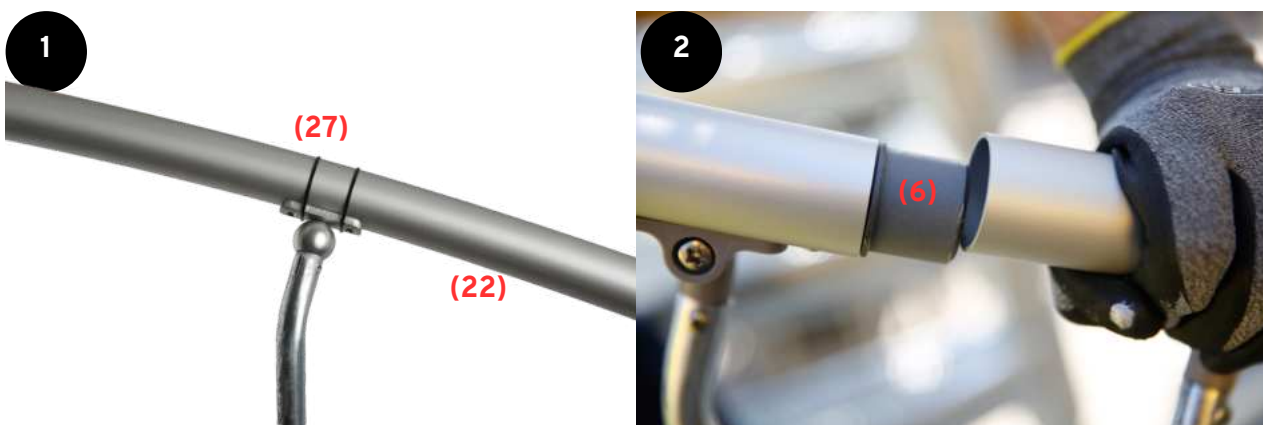



5) Montaje

Ahora alinee las lengüetas en paralelo al pasamanos girando la bola en la varilla. El ángulo de la lengüeta puede modificarse girando la varilla (fig. 3).

Importante: Compruebe la verticalidad de las varillas utilizando un nivel de burbuja (fig. 4).

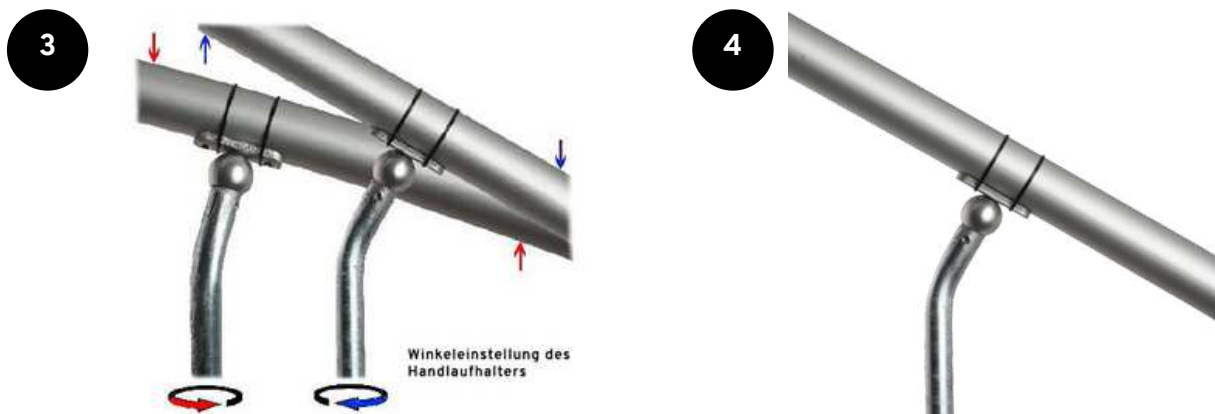

Una vez alineados, atornille el soporte a la varilla de la barandilla con el tornillo de cabeza plana (11).

En el siguiente paso, marque los orificios con un lápiz y taládrelos en el pasamanos con la broca de Ø4 mm (27) suministrada. A continuación, tome los tornillos avellanados (19) y atornille el soporte del pasamanos al tubo del pasamanos (fig. 5).





5) Montaje

Paso 11

Una vez atornillados los pasamanos, se retiran las bridas para cables y se aprietan los tornillos prisioneros que sujetan las varillas de la barandilla en los extremos de los peldaños (fig. 1).

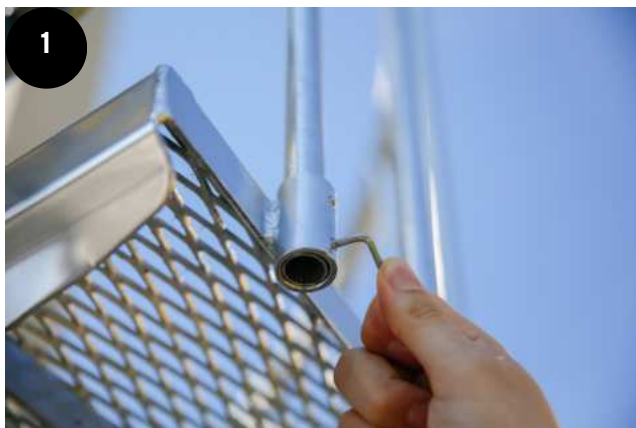

Paso 12

Recorte la varilla de la barandilla que sobresale hacia abajo utilizando una sierra para metales o una amoladora de corte. Después de sellar los puntos de corte con el spray de zinc-aluminio (24) adjunto, introduzca desde abajo los tapones de tubo de plástico (20) en las varillas de la barandilla.



A continuación, taladre un orificio aproximadamente en el centro de cada tapa de plástico con la broca de Ø5 mm (27) incluida. Si no se taladran los agujeros, el agua de lluvia helada puede dañar las varillas de la barandilla y los soportes del pasamanos a temperaturas bajo cero.



5) Montaje

Paso 13

Coloque ahora el tubo terminal (16) en la parte superior del tubo de soporte central y fíjelo con los tornillos prisioneros (5) (fig. 1). A continuación, fije la tapa redonda (2) en la parte superior del tubo terminal (fig. 2).

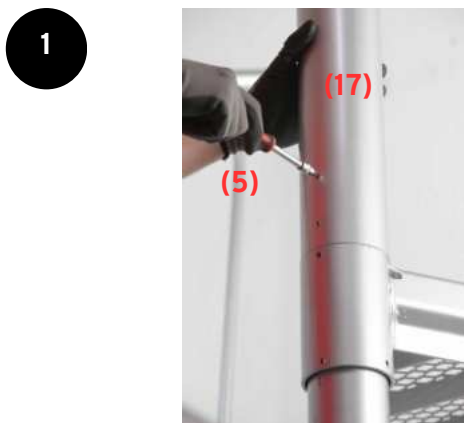

Paso 14

Los peldaños, el rellano y el tubo terminal se fijan ahora adicionalmente con manguitos de sujeción (9). Para ello, taladre con el taladro un agujero de $\text{Ø}5$ mm en el tubo de soporte central a través de los agujeros previstos en los peldaños e introduzca el manguito de sujeción.





5) Montaje

Paso 15 (acero)

Una vez fijados los peldaños, el rellano y el tubo terminal, la barandilla se monta en el rellano de la siguiente manera:

1. Taladre previamente los orificios para los zócalos (7) (fig. 1).
2. Aterraje una rosca en los orificios utilizando la terraaja (25).
3. Inserte el tornillo de cabeza hexagonal (28) en el zócalo y, a continuación, atorníllelo en los orificios preparados (fig. 2).
4. Fije las varillas de la barandilla (15) con el tornillo prisionero.
5. Atornille el soporte de la barandilla (10) y la varilla de la barandilla (16) con el tornillo de cabeza semirredonda (11) (fig. 3).

Asegúrese de que la curva del soporte del pasamanos no apunte hacia afuera, sino hacia el interior del rellano.

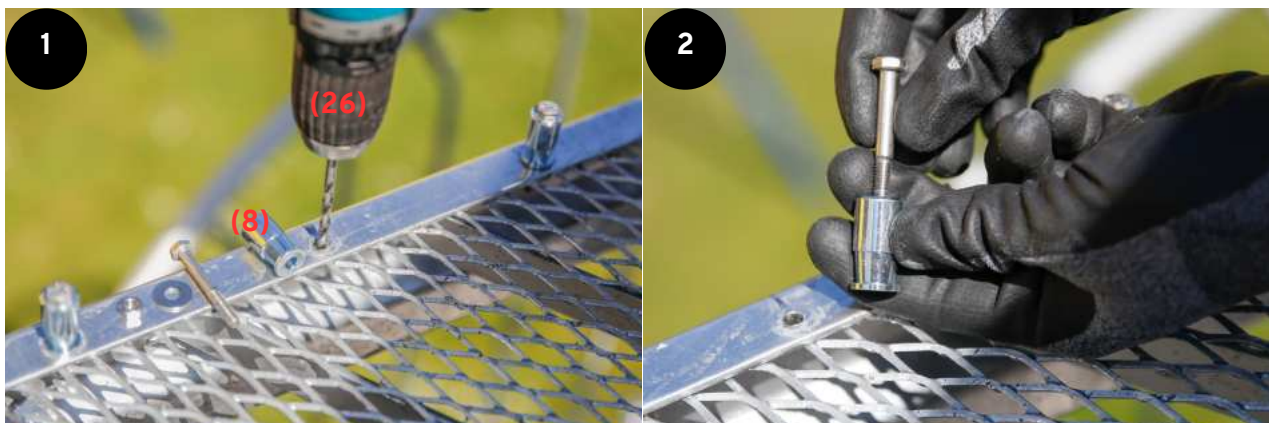

3





5) Montaje

Paso 15 (WPC)

Una vez fijados los peldaños, el rellano y el tubo terminal, la barandilla se monta en el rellano de la siguiente manera:

1. Pretaladre los agujeros para el zócalo (7), a 2 cm del borde (fig. 1).
2. Aterraje una rosca en los orificios utilizando la terraja (25).
3. Inserte el tornillo de cabeza hexagonal (28) en el zócalo y, a continuación, atorníllelo en los orificios preparados (fig. 2).
4. Fije las varillas de la barandilla (15) con el tornillo prisionero.
5. Atornille el soporte de la barandilla (10) y la varilla de la barandilla (15) con el tornillo de cabeza semirredonda (11) (fig. 3).

Asegúrese de que la curva del soporte del pasamanos no apunte hacia afuera, sino hacia el interior del rellano.





5) Montaje

Paso 16

Ahora fije el pasamanos. En primer lugar, taladre un orificio de $\varnothing 5$ mm en el tubo terminal y corte allí una rosca con la terraja (25) suministrada (fig. 1). Introduzca el tornillo de cabeza hexagonal (29) a través de la conexión universal (14) y atorníllelo en la rosca previamente creada (fig. 2).

Taladre un orificio de 4 mm a través del pasamanos (13) y la conexión universal (15) y atorníllelos con el tornillo de cabeza lenticular (11) suministrado.



Asegúrese de que el pasamanos del rellano (13) está fijado a la pared o barandilla adyacentes. Compruebe todas las uniones atornilladas de la escalera y apriételas si es necesario.



5) Montaje

Paso 17

Rocíe todas las zonas donde haya introducido los manguitos de sujeción o donde se hayan atornillado los tornillos prisioneros con el spray de zinc (24) suministrado. Los restos de galvanizado sobrantes en las rejillas de los peldaños pueden eliminarse fácilmente con un cepillo de mano.



SCALANT es una marca de

Daniel Gruppe GmbH

Daimlerstraße 17

32312 Lübbecke (Alemania)

Correo-e info@scalant.eu